

# TurboTouch®

**MADDOX ENTERPRISES, INC.**

633 SOUTH COLLEGE DRIVE

SANTA MARIA, CA 93454

PHONE: 888-404-8402

WWW.TURBOTOUCH.COM

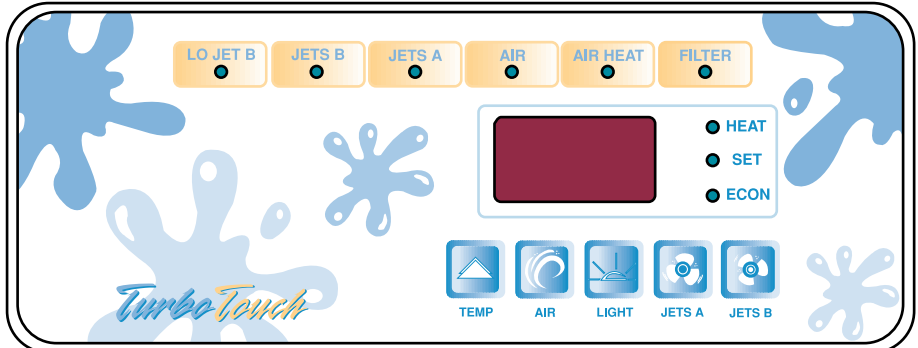
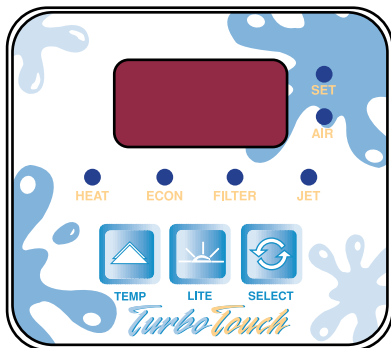
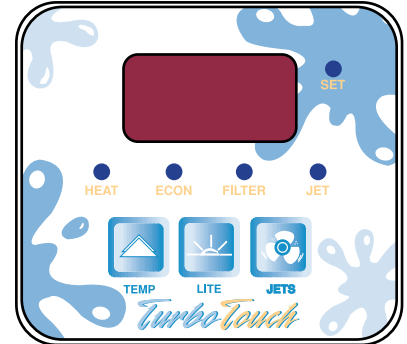
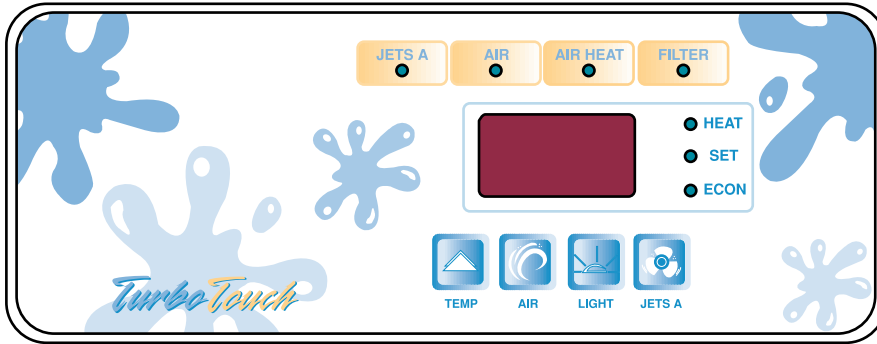

## SPA CONTROL OWNERS MANUAL

**240-VOLT SPA EQUIPMENT FOR PORTABLE SPAS**

**NON-GFCI ELECTRICAL**

**Patent Number 5932127**

**Model: CAT P2R-G39**

# IMPORTANT SAFETY INSTRUCTIONS

The following precautions are important for the safe and enjoyable use of spas. Misuse of any product can be harmful. Please observe these precautions and enjoy the healthful and relaxing use of your spa.

1. **READ AND FOLLOW ALL INSTRUCTIONS.**
2. **WARNING** - To reduce the risk of injury, do not permit children to use this product unless they are closely supervised at all times.  
**DANGER -- RISK OF ACCIDENTAL DROWNING.** Extreme caution must be exercised to prevent unauthorized access by children. To avoid accidents, ensure that children cannot use the spa unless they are supervised at all times. In fact, anyone using a spa should not be alone during use.
3. **DANGER** - To reduce a risk of injury to persons, do not remove suction fittings. Never operate a spa or hot tub if the suction fittings are broken or missing. Never replace a suction fitting with one rated less than the flow rate marked on the equipment assembly.
4. The spa owner is responsible to ensure that all electrical connections comply with any state and local codes and the National Electric Code in effect at the time of installation of this electrical equipment.
5. All electrical connections to the spa should be made with copper conductors only. These electrical connections including conductors, circuit breakers and fuses must be sized to meet the maximum (MAX.) Amperage and Voltage as specified on the electrical control box. The spa electrical equipment will not operate properly if other electrical appliances share the circuit that the spa equipment is connected to.
6. Remove electric power from the spa equipment by turning off the main circuit breaker and disconnecting the power cord (if applicable) *before* any service on the spa equipment is performed.
7. **DANGER** - To reduce a risk of injury, connect 120V powered systems to a grounded, grounding type receptacle only. **Do not** bury the power cord. The 120V power cord is designed to fit only a 20 Amp receptacle. **Do not** modify the power cord for any reason to fit any other supply receptacle. **Do not use** an extension cord. Replace damaged cord **immediately**.
8. A pressure wire connector is provided on the surface of the control box inside the spa to permit connection of a minimum No. 8 AWG solid copper bonding wire between this point and any metal equipment, metal enclosures of electrical equipment, metal water pipe, or conduit within five feet of the unit as needed to comply with local requirements.
9. **WARNING - FOR INDOOR USE ONLY.** The electrical equipment is intended for indoor use only and is not intended for outdoor use. This equipment must be protected from the weather at all times. The compartment that the equipment is installed in must provide for water drainage away from electrical components. It is the spa owners' responsibility to insure that the final installation of this equipment does not permit standing water in the equipment area.
10. This equipment must be accessible after final installation for service. This access must be provided without draining the spa.
11. **NEVER** operate the spa equipment while the spa is empty. This could severely damage the equipment and the spa and presents a potential fire risk!
12. **DANGER - RISK OF ELECTRIC SHOCK.** Do not permit any electric appliance, such as light, telephone, radio, or television within 5 feet (1.5 m) of a spa or hot tub. Do not try to adjust or touch the spa equipment such as the heater, pump, blower or other electrical appliance while in a spa.
13. To avoid unauthorized use of your spa, make sure there is a fence with a self-closing, self-latching gate around your spa. If your spa is indoors, lock doors leading to the spa.

**14. WARNING** - This equipment is provided with a ground fault circuit-interrupter (GFCI) located on the front of the electrical control box. Before each use of the spa, push the test button while the spa electrical equipment is connected to power and is operating. The spa equipment should stop operating and the reset button on the GFCI should pop outward. Push the reset button. The spa equipment should now operate normally. If the interrupter does not perform in this manner, there is a ground current flowing indicating the possibility of an electric shock. Disconnect the power from the spa equipment until the fault has been identified and corrected.

**15. WARNING** - To reduce the risk of injury, please observe the following:

Before entering the spa, always measure the water temperature with an accurate thermometer. Tolerance of water temperature regulating devices may vary as much as plus/minus 5 degrees F (3 Degrees C). Spa water temperature of 100 degrees is generally safe and enjoyable for most adults. Extended use of a spa at this temperature will, however, raise your body temperature and you may experience some discomfort. For long periods of soaking, the temperature of the spa water should be at your normal body temperature (98 to 99 degrees). As you raise the temperature of your spa water you should reduce the amount of time you spend in the spa. Always use an accurate thermometer to measure your spa water temperature to limit your stay in your spa as suggested below. Twenty minutes is about the limit for 102-degree water. Limit your stay in water above 102 degrees to about 10 minutes. Don't soak in water hotter than 104 degrees because higher temperatures can result in drowsiness, hyperthermia or heat stroke.

Hyperthermia occurs when the internal temperature of the body reaches a level several degrees above normal body temperature of 98.6 degrees F. The symptoms of hyperthermia include dizziness, fainting, drowsiness, lethargy, and an increase in internal body temperature. The effects of hyperthermia include unawareness of impending hazard, failure to perceive heat, failure to recognize the need to exit the spa, fetal damage in pregnant women, physical inability to exit spa, and unconsciousness resulting in a danger of drowning.

Children's body temperature can increase more rapidly than adults in the same water with elevated temperatures (above 99 degrees). Children should spend less time in water above body temperature than adults.

Pregnant women should consult a physician during pregnancy before entering the spa. This is especially true during the first 90 days of pregnancy (or for those who are considering getting pregnant in the near future). Excessive water temperature has a high potential for causing fetal damage during early months of pregnancy. Pregnant or possibly pregnant women should limit spa water temperatures to 100 degrees F (38 degrees C).

Persons suffering from obesity or with a medical history of heart disease, diabetes, high or low blood pressure, or circulatory system problems should consult their physician before using the spa.

People with infections, sores or the like should not use the spa. Warm and hot water may allow the growth of bacteria if it is not properly disinfected. Be sure to use a disinfectant such as chlorine regularly.

The use of a spa while under the influence of alcohol and/or drugs may lead to unconsciousness with the possibility of drowning. Persons on medication should consult with their physician before entering the spa since some medication may induce drowsiness while other medication may affect heart rate, blood pressure, and circulation.

**16.** Always enter and exit the spa slowly. Wet surfaces can be slippery and may cause a fall.

**17.** Suction through drains and skimmers is powerful when the jets in the spa are in use. Care should be exercised to insure that the covers for the drains and skimmers are in place and in good condition. Damaged covers can be hazardous to small children and adults with long hair. Should any part of the body be drawn into these fittings, turn off spa immediately. As a precaution, long hair should not be allowed to float in the spa. Use a bathing cap to control long hair.

**18.** The electrical supply of this product must include a suitably rated switch or circuit breaker to open all ungrounded supply conductors to comply with section 422-20 of the National Electric Code, ANSI/NFPA 70-1987. The disconnecting means must be readily accessible to the tub occupant but installed at least 5 feet (1.5 m) from the tub water.

**DANGER -- RISK OF ELECTRIC SHOCK.** Install at least 5 feet from all metal surfaces. A spa may be installed within 5 feet of metal surfaces if, in accordance with the National Electric Code, each metal surface is permanently connected by a No. 8 AWG (8.4 mm<sup>2</sup>) solid copper conductor attached to the wire connector on the terminal box that is provided for this purpose.

**SAVE THESE INSTRUCTIONS**

## FILLING THE SPA WITH WATER

### NEVER APPLY POWER TO AN EMPTY OR PARTIALLY FILLED SPA

- A. Turn off the spa circuit breaker located at your house circuit breaker panel.
- B. Open all adjustable jets in the spa fully open.
- C. Fill the spa to a level of approximately 3 inches **above** the bottom of the skimmer openings. This is the normal operating level.
- D. Turn the main circuit breaker on at this point (remember, the spa **must be filled** to operating level).

## SPA CONTROL

### 1. SPA SIDE CONTROLS

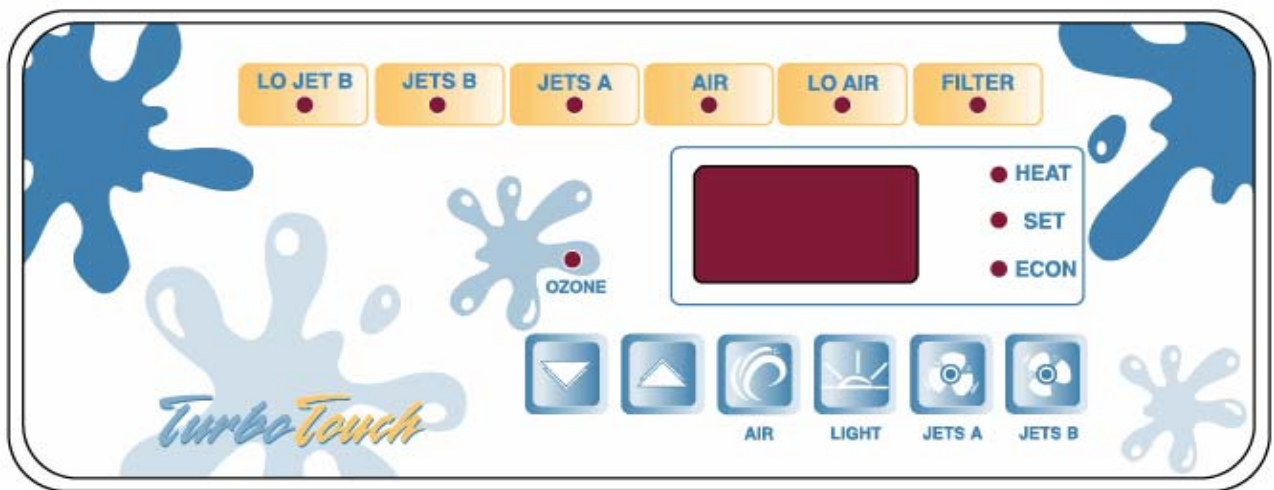
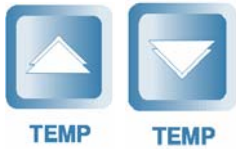

Figure 1

The spa side controls allow you to control the spa equipment safely from within the spa. If your spa is equipped with an optional ozone unit, it will be controlled by the filter timer and activated at the same time as the filter pump. For additional filtering and ozonation, select FILTER as discussed below. Pushing buttons may cause a heat cycle.

## 2. HEATER THERMOSTAT



The temperature buttons located on the left of the control panel control the heater. Push the temperature button to increase temperature. When the buttons are pushed, the SET light will illuminate. When the desired temperature is selected, stop pushing the temp button and the control will exit the SET mode. When the set temperature is increased above 104 F, the set display drops to 70 F. The length of time required to reach the desired temperature depends on several factors. The volume of water, temperature of the water, outside air temperature, spa size, type of spa insulation and the type of power used to heat the spa are all factors. The power will give the best guide for speed of heating on your spa. On 120 volts, the spa should heat at a rate of 2 to 3 degrees an hour. On 240 Volts, the spa should heat about 6 to 10 degrees an hour. Setting the temperature control to its maximum **will not** heat the spa water faster than setting the control to the desired temperature. At any rate, do not expect to feel hot water from the jets while the spa is initially heating.

An accurate thermometer should be used to measure water temperatures. Be aware that spa and pool thermometers can be off by as much as 5 degrees or so. For accurate readings, use a medical thermometer.

## 3. HEATER/FILTER AUTOMATIC CYCLES

**Setting the filter action:** Push the LIGHT and JETS buttons at the same time. The display will show the current daily filter settings. Push the JETS button to step through the selections of filter times. The settings showing an **H** after the number will allow automatic heating. The settings with an **E** will allow heat cycles to start only during filtration time. The setting with an **A** or **P** after it is the time of day. The **A** and **P** represent AM and PM.

**Automatic filtration:** There are two filter cycles each day, each lasting for half of the selected filter time. When the spa powers up or loses power temporarily, the control thinks that it is 6 o'clock PM. Based on this, filter cycles start 12 hours and 20 hours later. The filter time selected is split between the two filter cycles. If additional filtration is required, turn the filter pump on by itself from the control panel using the JETS button. The ECON light should be off, but the heater light may be on or off.

**Automatic heating mode:** Set the filter duration with the **H** after the number for automatic heating. The number represents the total hours per day of automatic filtration. There are three choices of automatic heating and filtering. These choices are **4Hours**, **6Hours** and **8Hours** of filtration. The filtration time is split into two filter times that are half of the total time selected. The spa will maintain temperature as required and does not depend on the filtration cycle to heat. This mode is most effective to maintain constant temperature. The spa will heat itself every two hours or so. If someone operates the controls, the spa will immediately heat if heat is required.

**Timed heating mode:** Set the filter duration with the **E** after the number for timed heating. The number represents the total hours per day of automatic filtration. There are three choices of timed heating and filtering. These choices are **4E** hours, **6E** hours and **8E** hours of filtration with timed heating. The filtration time is split into two filter times that are half of the total time selected. The spa will depend on the filtration cycle to start heating and the spa will heat to the thermostat setting. This mode is most effective to heat during the filter times. If someone operates the controls,

the spa will heat when heat is required one time in addition to the filtration-heat cycles.



LITE



JETS

**Setting the time of day:** Push the LITE and JETS A buttons at the same time. The display will show the current daily filter setting. Push the JETS A button to step through the selections of filter times. Continue pushing the JETS A button until the setting with an **A** or **P** after it appears. The **A** and **P** represent AM and PM.



TEMP



TEMP

Push the TEMP buttons to change the time of day to the closest hour.



JETS

Once the correct hour has been selected, press the **JETS** button to select the filter time desired.

#### 4. PUMP SELECTION



JETS

The push buttons, located on the spa side controller, enable the occupant of the spa to select jet functions. Spas with two pumps will also use the jets B functions

##### A. ECONOMY (ECON).

When a function is selected it will only be active for 30 minutes (except FILTER). The control will then revert to ECONOMY for filtering and heating as necessary.

##### B. FILTER

For continuous filtration, **push the JETS button once and the FILTER mode will be activated. You cannot select this feature while the spa is heating.** Filter is used to force filtration and does not revert after 30 minutes to ECONOMY mode. If the spa needs additional filtration, then set the control on FILTER until the spa water is clear. The need for this function will be rare but will be needed from time to time.

##### C. JETS A and JETS B

The **JETS** button will activate the desired jets in the spa. When the pump button is pushed the first time, the selected pump will be in the FILTER setting. When the same button is pressed again, the pump will change to the high-speed setting. Pressed again, Jets A will go off. If the spa is heating the filter will already be on so when the Jets A button is pushed it will cause the Jets A pump to go to Jets A and then the next push back to filter. If your spa has JETS B then the Jets button will also activate JETS B.

## 5. AIR BLOWER SELECTION



The **AIR** push-button on the control panel is used to turn on the air blower. Press the button the first time to turn on LO AIR. Press the button a second time to turn on AIR. Press the button a third time to deactivate the air blower.

## 6. UNDERWATER SPA LIGHT BUTTON



The **LIGHT** switch controls the spa light. This light is used at night to allow safe entry and exit from the spa. The spa light has two settings of on and off.

## 7. HEATER HIGH LIMIT

If the **heater** reaches a temperature that is higher than normal, the HEAT indicator will flash. While the HEAT indicator is flashing, the heater will not heat the spa. Pressing the LIGHT switch or JETS switch on the control panel can reset the heater Hi Limit **once the heater has cooled**. The heater may only be reset after the heater has cooled off and the problem causing the higher than normal temperature has been corrected. Several conditions could cause this to happen: low water level in the spa, shut-off valves closed while the heater is on, clogged plumbing lines, dirty filter or thermostat malfunction.

## 8. FREEZE PROTECTION

This is an automatic function of the control system. When the outside air temperature drops near a freezing condition, then the control system turns on the low speed pump to keep the exposed pipes from freezing. When the outside air temperature rises, the pump is turned off again.

## 9. INVERT TEMPERATURE DISPLAY

The temperature display may be inverted so that it may read more easily while you are inside the spa. This is done by pushing the light and up temperature at the same time.

## GUIDELINES FOR SPA MAINTENANCE

The maintenance and care of is simple and easy to perform. Keep the spa covered when not in use. This reduces heat loss (power consumption) and keeps out leaves and other foreign materials.

Maintaining proper water chemical balance is essential for the comfort and safety of the user. Water mineral content varies constantly and is affected by evaporation and the use of cleansing and maintenance chemicals. If the mineral content deviates from a pH level of 7.2 to 7.6, the condition and operation of your spa may be adversely affected. A pH level outside 7.2 to 7.6 can cause deposits to form on spa walls or filter cartridge or on the heater and plumbing.

Since the water capacity of your spa is far less than that of a swimming pool, the chemical reaction caused by the presence of one or more persons in the spa rapidly changes the quality of the water in the spa. For this reason, it is important to check the chlorine or bromine level, the pH level and total alkalinity of the water often. Add the proper chemical to maintain proper chemical balance. A rule of thumb on spa chemistry is that you never add two chemicals to your spa in the same day. Check water chemistry at least once a week (more often depending on spa usage). The proper time to add chemicals is AFTER you use the spa never before.

Failure to maintain proper chemical balance in your spa will result in premature failure of your spa components such as the spa cover, plumbing, electrical parts, spa finish and other components. Chemical imbalance can void your warranty.

The spa water should be changed periodically depending upon spa usage and other conditions that affect water quality. When the water in the spa cannot be cleared through chemistry or the pH will not adjust, this is an indication that the water in the spa needs to be changed. If the water remains cloudy all the time, increase the filtration time at least an hour each day to a maximum of 5 hours a day. Clean the filter cartridge more often while you are trying to clear the spa water. Try additional filtration for a week. If the spa water is still cloudy or dirty after a week of extended filtering, empty the water out of the spa. Turn off the power to the spa before you drain the spa. Refill the spa following the directions found at the beginning of this manual.

The spa filter should be cleaned every week when the spa is used every day. To clean the filter, remove the filter cartridge from the spa and spray the outside of the cartridge with garden hose to remove debris. Re-install the cartridge after cleaning.

## ESSENTIAL CHEMICALS AND THEIR USE

THE FOLLOWING INFORMATION IS GIVEN HERE STRICTLY AS A GUIDE. WHEN USING SPA CHEMICALS, ALWAYS FOLLOW THE INSTRUCTIONS PROVIDED WITH THE CHEMICAL FROM THE CHEMICAL MANUFACTURER. NEVER ADD LARGE QUANTITIES OF ANY CHEMICAL (MORE THAN ONE OUNCE IN AN 8 HOUR PERIOD) TO YOUR SPA! STORE CHEMICALS IN A COOL DRY PLACE SO THAT CHILDREN CANNOT HANDLE THEM. NEVER STORE CHEMICALS IN THE SPA CABINET NEXT TO THE EQUIPMENT.

- A. CONCENTRATED CHLORINATING GRANULES.** The minimum chlorine level of free chlorine in your spa is 1.0 PPM (parts per million). The maximum level of free chlorine in your spa is 2.0 PPM. Check chlorine level at least twice a week. Never add more than 1/2 ounce of this chemical during an eight-hour period. Liquid chlorine should not be used in your spa.
- B. ORGANIC POLYMERS** are used in various forms. These chemicals clear up cloudy water and prevent calcium deposits from forming on the spa finish and plumbing. Use as directed by the chemical manufacturer.
- C. "METAL GON"** or equivalent prevents iron in the spa water from staining the spa finish. This chemical is added to the spa only when the spa is filled for the first time or when the spa is emptied and re-filled. Use as directed by chemical manufacturer.
- D. SILICONE EMULSION.** This chemical quickly disperses foam that may occasionally form on the spa water surface. This chemical is called foam down or foam gone and is compatible with other spa chemicals of the same manufacture. Use as required.
- E. SEALER - POLISH.** Is usually a silicone compound that provides protection and a glossy finish to the acrylic surfaces of the spa exposed to air. This chemical is used to clean and polish the spa surfaces above the water line. Use only a soft cloth to apply such chemicals to the spa surface to avoid scratches. Use as the chemical manufacturer directs.

## WHEN THINGS AREN'T QUITE RIGHT

---

The following list is a guide for the spa owner. If the trouble cannot be corrected using the list below, then ask your spa dealer for service. Service by an unauthorized serviceman or spa owner could result in damage that will not be covered under warranty.

---

### **TROUBLE ----->ACTION**

---

#### **Equipment does not operate.**

Check to see if the power cord is plugged in.

Check the main circuit breaker.

Check the GFCI to see if it has tripped.

If the GFCI trips repeatedly, locate the source of the fault before using the spa.

---

#### **Air Blower (if applicable) not working.**

Push AIR switch to activate the blower and illuminate the "AIR" light.

See if the control panel is connected to the control box.

See that the blower is plugged into the control box.

See "**Equipment does not operate**".

---

#### **Spa light not working.**

Push LIGHT switch to OFF and then push again to ON.

See if the control panel is connected to the control box.

Replace the light bulb.

Insure that the light power cord is plugged in.

---

#### **Jets are weak or surging.**

Insure the spa is filled to the proper level with water.

Be sure that the shut off valves located in the pump lines are completely open.

Open the air control valves.

Remove the filter cartridge and see if the jets improve. If so, clean or replace cartridge.

---

#### **FILTERS pump not working (JETS A LED BLINKS).**

Push the LIGHT switch until the light goes off and then push the JETS switch once to activate the FILTER mode.

The low pump operates for heating and filtering.

Insure that the pump is plugged into the control box.

Open all the spa jets.

Open any shut off valves in the equipment area.

Clean or replace filter.

See "**Equipment does not operate**".

### **High-speed pump not working.**

Push the JETS switch and then push the JETS switch once. (The "JETS" light will illuminate steady).

See if the control panel is connected to the control box.

Check the suggestions listed for "**FILTER pump not working**".

### **No heat.**

Insure that the "set temperature" is the desired temperature.

The heater has not had enough time to heat the spa. It takes several hours to heat a cold spa.

On 120 Volt installations, the spa only heats in the ECON mode.

The air blower and jets can cool the spa. Turn off the blower and jets to allow the spa to heat.

Blinking JETS A indicator means the water is not flowing by the heater when it should be. Look for cause of trouble below as if Heat Indicator is blinking.

Blinking ECON indicator means that one of the temperature sensors is faulty or not in its correct position.

See "**Equipment does not operate**".

While the HEAT indicator is blinking the heater will not heat the spa (The Hi Limit has tripped). Pressing the LIGHT switch or JET switch on the control panel can reset the heater Hi Limit. Look for the cause of tripping in **Spa will not get hot enough** below:

### **Spa will not get hot enough.**

The water level in the spa is not halfway between the top and the bottom of the skimmer opening.

The shut off valves are not completely open.

The filter cartridge is dirty or needs replacing. (Remove filter for 24 hours to allow spa to heat.)

The spa has been drained and refilled while the power was on the spa.

See "**No heat**"

### **Water is not clear.**

Check pH and chlorine in spa.

Clean or replace filter cartridge.

Select FILTER for additional filtration (This pump position allows continuous filtering).

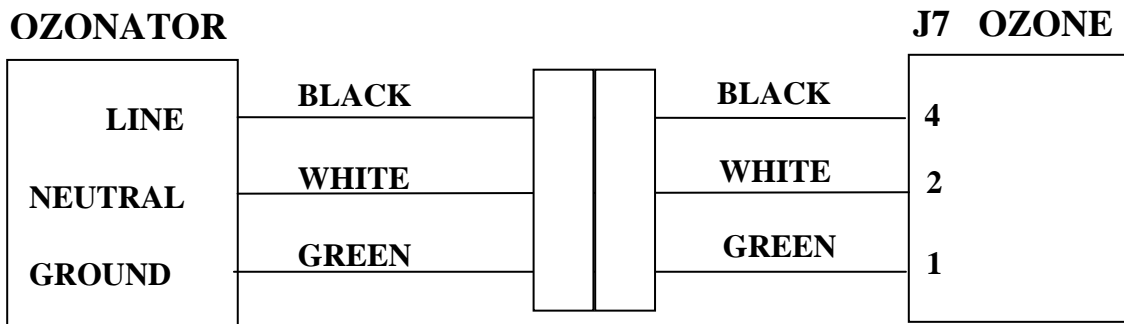
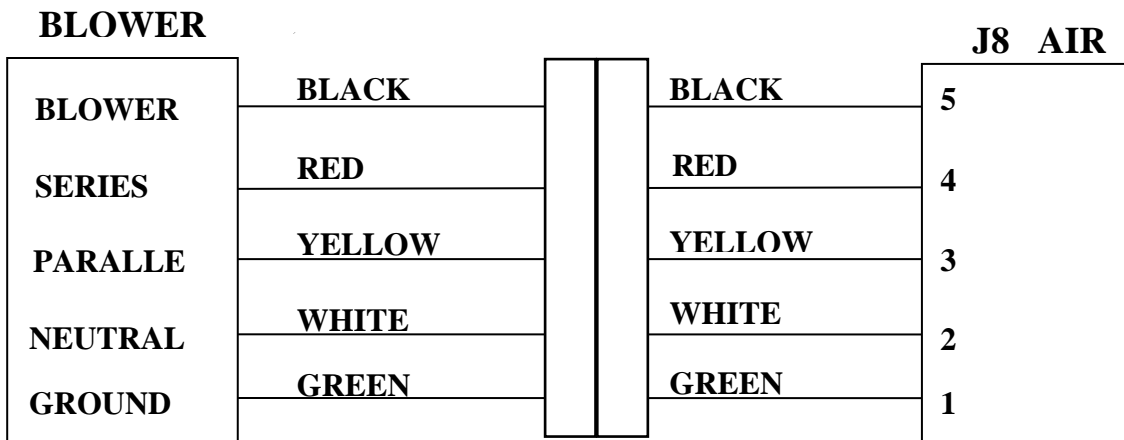
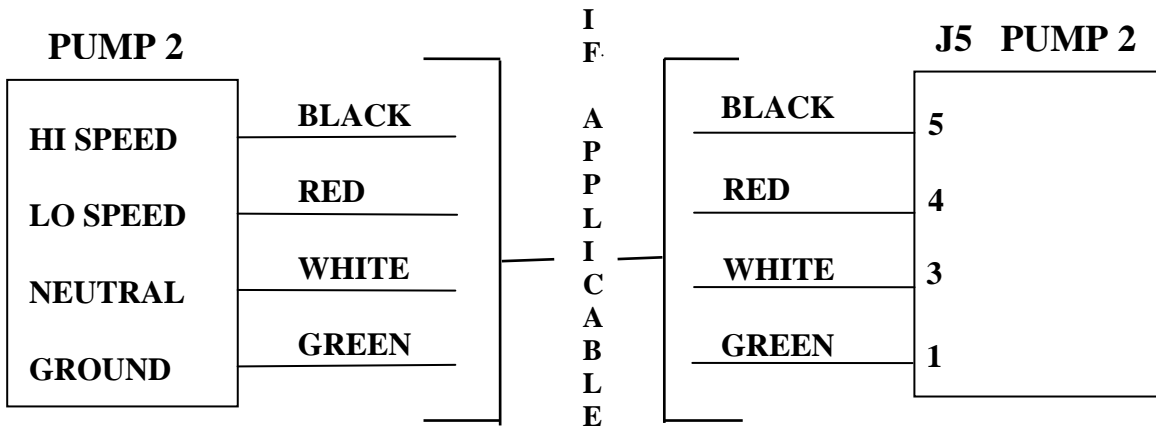
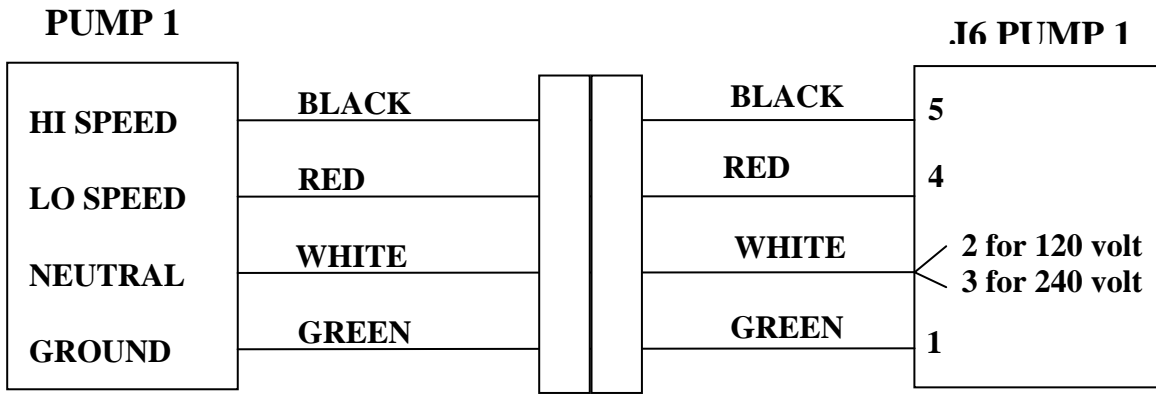

\* Pin 1 on all of the PCB connectors is the pin closest to the edge of the board \*

# ELECTRICAL DIAGRAM

PROVIDE A READILY ACCESSIBLE  
DISCONNECTING MEANS DURING  
INSTALLATION.  
USE COPPER CONDUCTORS ONLY.

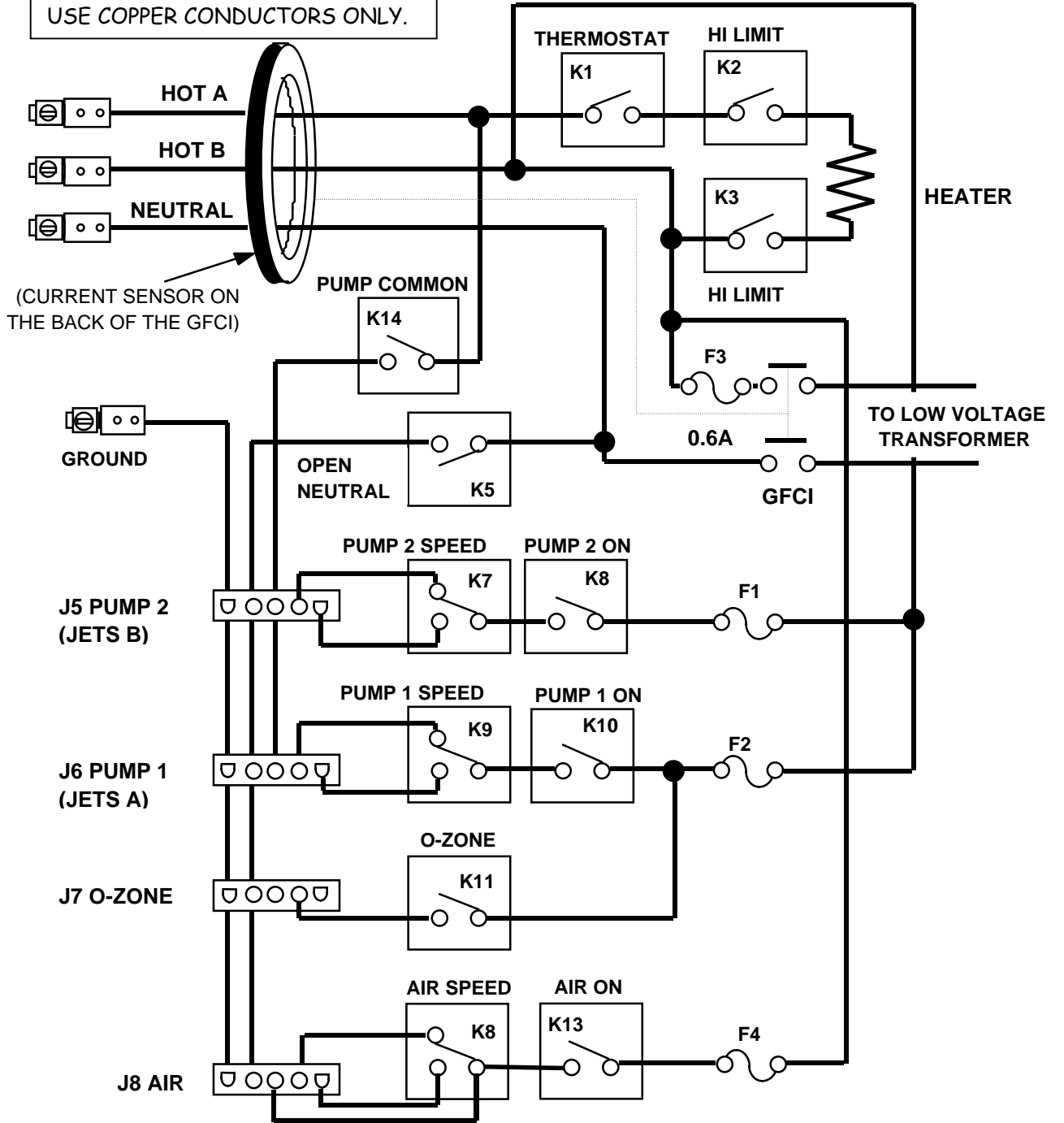

P2P-G39 AC WIRING

## **TWO-YEAR LIMITED WARRANTY**

Maddox Enterprises, Inc. (MEI) warrants that at the time of shipment, the products manufactured by MEI and sold hereunder shall be in conformity with descriptions referred to or set forth herein and shall be free of defects of material and workmanship. Maddox Enterprises, Inc. agrees at its option to repair or furnish a replacement for but not to install or remove any component thereof, which, within twenty-four months of the beginning of the warranty period shall upon examination by Maddox Enterprises prove defective. All components shall be returned freight prepaid.

## **ADDITIONAL TERMS AND CONDITIONS**

This warranty is expressly in lieu of any other warranties expressed or implied, including warranties of merchantability or fitness for purpose. No other person or entity has been authorized to make any warranty or promise of performance not included in this written warranty, and Maddox Enterprises, Inc. shall not be bound by any additional warranty or promise. This warranty does not cover component parts not manufactured by Maddox Enterprises, which are covered by separate manufactures' warranties. In no event shall Maddox Enterprises be liable for any indirect, inadvertent, special, incidental or consequential damages or any other loss or inconvenience whatsoever. Some states restrict the exclusion or limitation of incidental or consequential damages. This warranty does not include or cover labor or freight expense. All components found to have been subjected to abuse; misuse, mishandling, improper handling, improper installation, modification or service by other than an approved service person will not be covered by this warranty.

This warranty extends to the original retail purchaser only and is not transferable. This warranty takes effect upon purchase of the product by the original retail purchaser or six months from the date of manufacture, whichever occurs first.